

# Modeling Linear Viscoelasticity in Glassy Polymers Using Standard Rheological Models

M. Haghighi-Yazdi<sup>1</sup>, P. Lee-Sullivan<sup>\*1</sup>

<sup>1</sup>Department of Mechanical and Mechatronics Engineering, University of Waterloo

\*Corresponding author: Department of Mechanical and Mechatronics Engineering, University of Waterloo, Waterloo, Ontario, Canada, N2L 3G1; Email: pearls@uwaterloo.ca

**Abstract:** In this study, a capability has been developed for modeling the linear viscoelastic behaviour of a glassy polymer using COMSOL Multiphysics<sup>®</sup>. The two rheological models by Maxwell and Kelvin-Voigt were used for modeling stress relaxation and creep loading behavior, respectively, of a typical gas pipe under two modes of plane stress and plane strain. Comparison of COMSOL Multiphysics<sup>®</sup> results with corresponding results obtained from another commercial finite element software package validated the modeling. An advantage of the developed model is its ability to predict either the modulus or compliance of a glassy polymer when only one set of experimental data is available. This is readily achieved by conducting a 2D analysis using one of the two rheological models which corresponds to the available experimental data.

**Keywords:** Linear viscoelasticity, glassy polymer, rheological models.

## 1. Introduction

Glassy polymers are viscoelastic; i.e., they exhibit time- and temperature-dependant behaviour. Linear viscoelasticity can be modeled using rheological models, which are in the form of linear springs and dashpots connected in series or parallel. The two most well-known rheological models are the Maxwell and Kelvin-Voigt models. While these two models are employed in other finite element software packages such as ABAQUS<sup>®</sup>, they are not fully developed in COMSOL Multiphysics<sup>®</sup>. This work, therefore, has developed capability for modeling the linear viscoelastic behaviour of a glassy polymer using the generalized forms of the Kelvin-Voigt and Maxwell models. The modeling has been developed using the Partial Differential Equation (PDE) module of the software and hence, can be readily extended to the cases where structural mechanics is coupled

to other physics. An example of such coupled physics is the gas transport in polymer pipes, in which the triple physics of structural mechanics, mass diffusion, and heat conduction are involved [1-4]. The rheological models of generalized Maxwell and Kelvin-Voigt can also be used to characterize the modulus and compliance of a polymer material in stress relaxation and creep experiments, respectively. However, the modulus found from the Maxwell model cannot be directly converted to compliance in the Kelvin-Voigt creep model, or vice versa. We have therefore developed a finite element model which will enable the prediction of either the modulus or compliance using only one set of experimental data.

## 2. Theory and Governing Equations

The viscoelastic behaviour can be modeled using two well known rheological models; i.e., generalized Kelvin-Voigt (Figure 1) and generalized Maxwell models (Figure 2). In the generalized Kelvin-Voigt model, two basic elements of the Kelvin-Voigt model are linked in series with an elastic spring; and in the generalized Maxwell model, two basic Maxwell elements are connected in parallel to an elastic spring. In our approach, we applied two sets of basic Kelvin-Voigt and Maxwell elements to the generalized models. This is expected to better represent the viscoelastic behaviour of the polymer blend used in this study.

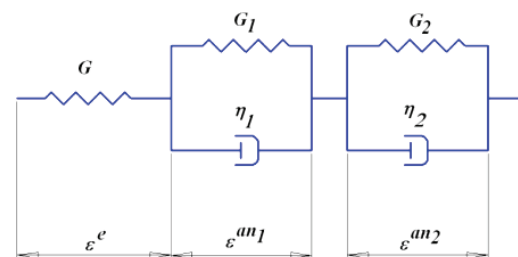

**Figure 1.** Schematic representation of the generalized Kelvin-Voigt model.

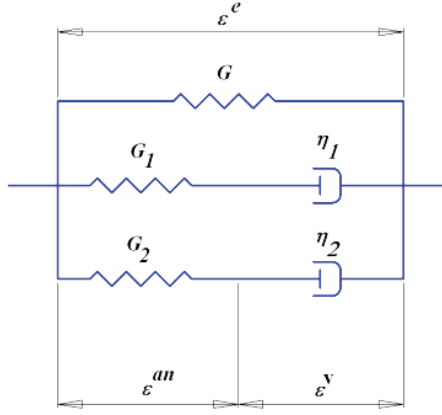

**Figure 2.** Schematic representation of the generalized Maxwell model.

The strain components and the properties related to the springs and dashpots are also illustrated in Figures 1 and 2. The elastic and viscoelastic components of stress and strain for these models have the following relations:

Generalized Kelvin-Voigt Model:

$$\underline{\underline{\varepsilon}} = \underline{\underline{\varepsilon}}^e + \underline{\underline{\varepsilon}}^{an_1} + \underline{\underline{\varepsilon}}^{an_2} \quad (1)$$

$$\underline{\underline{\varepsilon}}^{an_1} = \underline{\underline{\varepsilon}}^{v_1}, \quad \underline{\underline{\varepsilon}}^{an_2} = \underline{\underline{\varepsilon}}^{v_2} \quad (2)$$

$$\underline{\underline{\sigma}} = \underline{\underline{\sigma}}^e = \underline{\underline{\sigma}}^{an_1} + \underline{\underline{\sigma}}^{v_1} = \underline{\underline{\sigma}}^{an_2} + \underline{\underline{\sigma}}^{v_2} \quad (3)$$

Generalized Maxwell Model:

$$\underline{\underline{\varepsilon}} = \underline{\underline{\varepsilon}}^e = \underline{\underline{\varepsilon}}^{an_1} + \underline{\underline{\varepsilon}}^{v_1} = \underline{\underline{\varepsilon}}^{an_2} + \underline{\underline{\varepsilon}}^{v_2} \quad (4)$$

$$\underline{\underline{\sigma}} = \underline{\underline{\sigma}}^e + \underline{\underline{\sigma}}^{an_1} + \underline{\underline{\sigma}}^{an_2} \quad (5)$$

$$\underline{\underline{\sigma}}^{an_1} = \underline{\underline{\sigma}}^{v_1}, \underline{\underline{\sigma}}^{an_2} = \underline{\underline{\sigma}}^{v_2} \quad (6)$$

The governing equations for a viscoelastic material following two models of generalized Kelvin-Voigt and generalized Maxwell and for both cases of plane strain and plane stress are presented in the Appendix.

### 3. Use of COMSOL Multiphysics

In order to develop the equations for modeling linear viscoelasticity, a typical

example consisting of a pressurized pipe has been considered. This configuration gives a good example of geometry with curved edges that can be modeled in different modes. The meshed pipe as well as the applied boundary conditions is illustrated in Figure 3. Due to the part symmetry, only a quarter of the pipe is modeled.

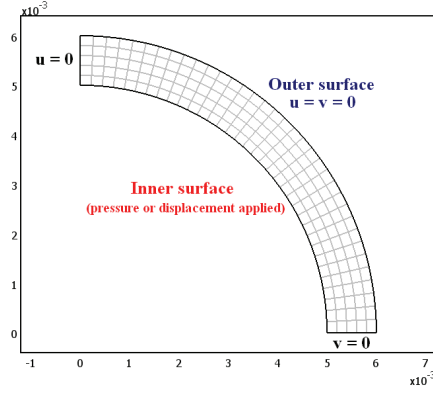

**Figure 3.** The geometry and boundary conditions of a quarter of a typical pipe.

It is assumed that the pipe is made of PC/ABS polymer blend which exhibits viscoelastic behaviour. Viscoelasticity is then modeled using the generalized Kelvin-Voigt and Maxwell models in Figures 1 and 2.

The software package of COMSOL Multiphysics® has different modules for modeling physics such as structural mechanics, heat transfer, diffusion, etc. One of these modules is the PDE module, which is used for equation based modeling [5]. Applying the PDE module of COMSOL Multiphysics® enables the modeling of a set of complicated PDEs to be relatively straight forward because of several advantageous features, such as being open source, easy to modify; and there is no need to write a user-defined element code (UEL). The PDE module provides the users with three forms of PDEs: coefficient form, general form, and weak form. The two coefficient form PDE and general form PDE are applied for linear viscoelasticity modeling in this study. The coefficient form and the general form have the following forms, respectively [5]:

$$e_a \frac{\partial^2 u}{\partial t^2} + d_a \frac{\partial u}{\partial t} + \nabla \cdot (-c \nabla u - \alpha u + \gamma)$$

$$+\beta \cdot \nabla u + au = f \quad (7)$$

$$e_a \frac{\partial^2 u}{\partial t^2} + d_a \frac{\partial u}{\partial t} + \nabla \cdot \Gamma = F \quad (8)$$

A transient analysis was performed on the pipe (Figure 3) assuming that the pipe's material follows the two rheological models of generalized Kelvin-Voigt and generalized Maxwell. The 2D analysis was performed in two cases of plane strain and plane stress. The outer surface of the pipe was fixed and the inner surface was exposed to two different loading conditions: a radial constant displacement of 0.1 mm inducing stress relaxation condition and a constant internal pressure equal to 1 MPa producing creep loading condition.

#### 4. Conversion between Modulus and Compliance

The compliance and modulus of the two rheological models used in this study; i.e., the models of the generalized Kelvin-Voigt and the generalized Maxwell, are represented in the form of Prony series, as follows:

$$D = D_e + D_1 \left(1 - \exp\left(-\frac{t}{\tau_1}\right)\right) + D_2 \left(1 - \exp\left(-\frac{t}{\tau_2}\right)\right) \quad (9)$$

$$E = E_e + E_1 \exp\left(-\frac{t}{\tau_1}\right) + E_2 \exp\left(-\frac{t}{\tau_2}\right) \quad (10)$$

where  $D$  represents compliance and  $E$  refers to modulus. The indexes 1 and 2 refer to the two branches used in the generalized models of Kelvin-Voigt and Maxwell (Figures 1 and 2). Compared to other models used for polymer materials such as the Kohlrausch-Williams-Watts (KWW) model, the Prony series form of the two models can be better used in finite element modeling [6].

There are five parameters in the modulus of the generalized Maxwell model; i.e.,  $E_e$ ,  $E_1$ ,  $E_2$ ,  $\tau_1$ , and  $\tau_2$ , which can be obtained by fitting a curve to the experimental data obtained from stress relaxation experiments. The details of

these experiments are presented in a work by the authors [7]. As an example, the modulus of the un-aged PC/ABS samples at 65 °C, has the following form:

$$E [GPa] = 1.033 + 0.851 \exp(-t/3023) + 0.273 \exp(-t/260)$$

In order to find the values of the five parameters of the generalized Kelvin-Voigt model ( $D_e$ ,  $D_1$ ,  $D_2$ ,  $\tau_1$ , and  $\tau_2$ ), which is equivalent to the model above; a 2D analysis is performed using the parameters of the generalized Maxwell model on a rectangular plate. A constant uniaxial stress is applied on the plate which simulates the creep loading. If the value of the uniaxial stress is set to unit, the obtained strain will become equivalent to the compliance of the material. The strain data points are then curve fitted to the compliance equation, Equation (9), to obtain a formula.

## 5. Results

### 5.1. Numerical Analysis

The transient analysis was performed in COMSOL Multiphysics® 4.0a and the results were compared to results obtained from similar analyses conducted using the software package of ABAQUS®. Figures 4 and 5 depict hoop stress contours obtained from the stress relaxation analyses of the pipe in, respectively, plane stress and plane strain modes performed in COMSOL Multiphysics®. Similarly, the results of creep analyses are illustrated in the form of radial strain contours in Figures 6 and 7 for plane stress and plane strain modes, respectively. The results of corresponding analyses performed in ABAQUS® are also shown in Figures 8 and 9 for the purpose of comparison.

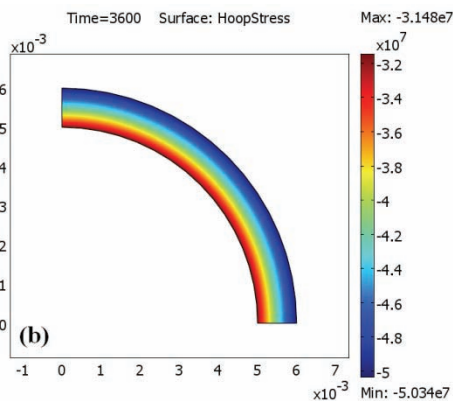
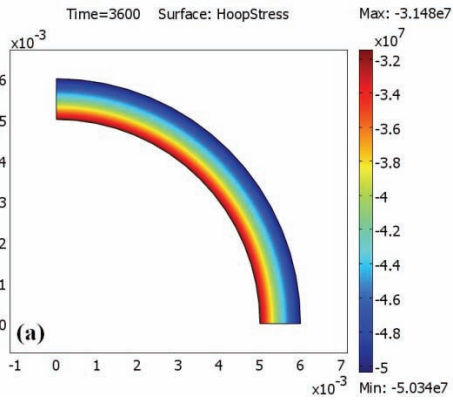

**Figure 4.** Hoop stress contour [Pa] obtained from a plane stress analysis using (a) generalized Kelvin-Voigt model, and (b) generalized Maxwell model conducted in COMSOL Multiphysics®.

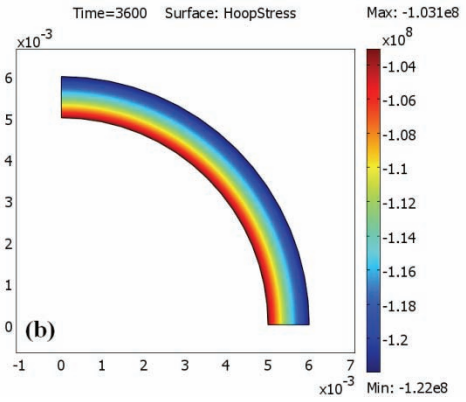
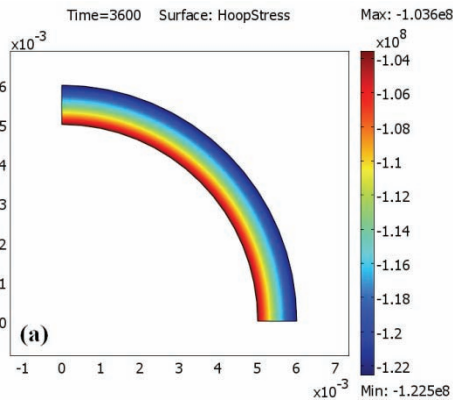

**Figure 5.** Hoop stress contour [Pa] obtained from a plane strain analysis in using (a) generalized Kelvin-Voigt model, and (b) generalized Maxwell model conducted in COMSOL Multiphysics®.

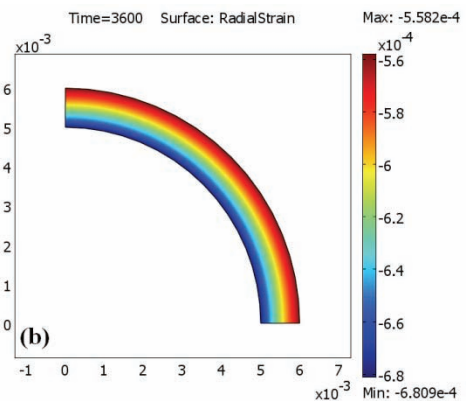
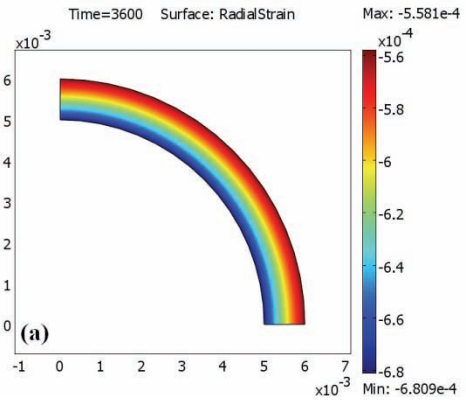

**Figure 6.** Radial strain contour obtained from a plane stress analysis using (a) generalized Kelvin-Voigt model, and (b) generalized Maxwell model conducted in COMSOL Multiphysics®.

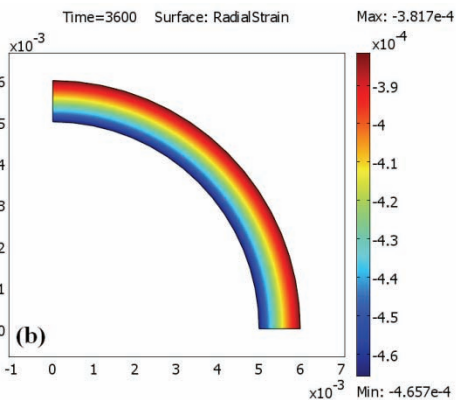
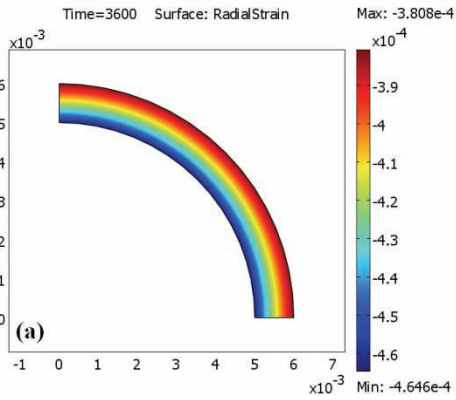

**Figure 7.** Radial strain contour obtained from a plane strain analysis using (a) generalized Kelvin-Voigt model, and (b) generalized Maxwell model conducted in COMSOL Multiphysics®.

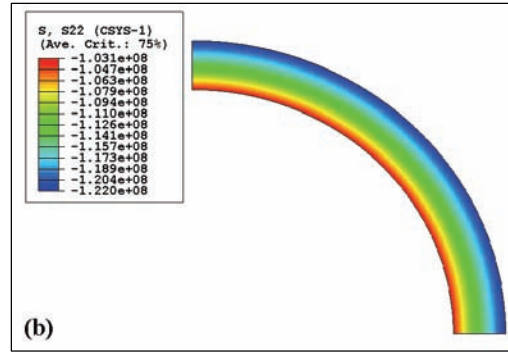
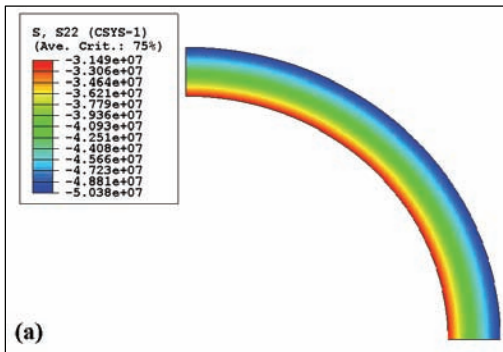

**Figure 8.** Hoop stress contour [Pa] obtained in (a) plane stress and (b) plane strain analyses in ABAQUS®.

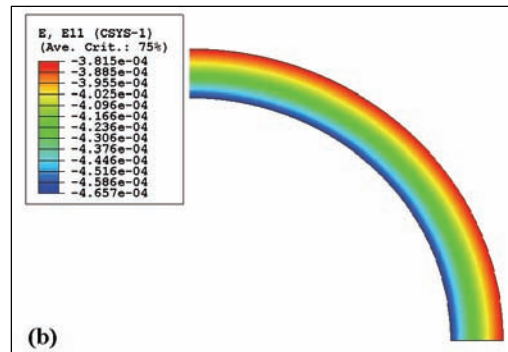
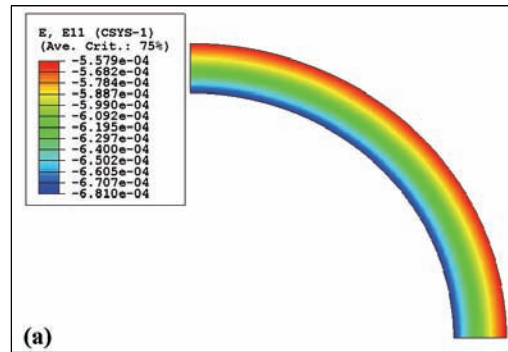

**Figure 9.** Radial strain contour obtained in (a) plane stress and (b) plane strain analyses in ABAQUS®.

There is a very good agreement between the results of COMSOL Multiphysics® analyses and the corresponding results from ABAQUS®, which confirms the validity of the PDE modeling in COMSOL Multiphysics® for linear viscoelastic materials.

## 5.2. Conversion between Modulus and Compliance

The strain data points were obtained from an analysis on a plate using the generalized Maxwell model. The data points were then curve fitted to the compliance equation, Equation (9), to obtain the following form:

$$D [1/GPa] = 0.464 + 0.444 (1 - \exp(-t / 5547)) + 0.061 (1 - \exp(-t / 296))$$

The above formula can then be used for modeling compliance of an un-aged sample at 65 °C using the generalized Kelvin-Voigt model. The obtained compliance is also verified using the relation it has with modulus [8] as follows:

$$\int_0^t E(t)D(t - \tau)d\tau = t \quad (11)$$

It was seen that the obtained parameters for compliance also satisfies Equation (11).

## 6. Conclusions

COMSOL Multiphysics® enabled us to readily model the linear viscoelastic behaviour of a typical glassy polymer. The model equations used the generalized Kelvin-Voigt and Maxwell models under plane stress and plane strain. The developed model can be used to represent the material's behaviour obtained from characterization tests conducted under creep or stress relaxation loading conditions. The model can also be employed to obtain the modulus or compliance of a polymer material system when experimental data is available for only one of the loading modes. Potentially, this approach can be used to analyze polymer behavior involving structural mechanics coupled with other physical mechanisms.

## 7. References

1. Rambert, G., Grandidier, J. -C., Cangemi, L., A Modelling of the Coupled Thermo-diffusion-Elastic Linear Behaviour. Application to Explosive Decompression of Polymers, Oil &

Gas Science and Technology – Rev. IFP, **58**(5), 571-591 (2003).

2. Rambert, G., and Grandidier, J. -C., An Approach to the Coupled Behaviour of Polymers Subjected to a Thermo-Mechanical Loading in a Gaseous Environment, European Journal of Mechanics A/Solids, **24**, 151-168 (2005).

3. Rambert, G., Jugla, G., Grandidier, J. -C., A Modelling of the Direct Couplings between Heat Transfer, Mass Transport, Chemical Reactions and Mechanical Behaviour. Numerical Implementation to Explosive Decomposition, Composites: Part A, **37**, 571-584 (2006).

4. Rambert, G., Grandidier, J. -C., and Aifantis, E. C., On the Direct Interactions Between Heat Transfer, Mass Transport and Chemical Processes Within Gradient Elasticity, European Journal of Mechanics, A/Solids, **26**(1), 68-87 (2007).

5. COMSOL Multiphysics User's Guide, COMSOL Multiphysics 4.0a Documentation.

6. Taylor, R. L., Pister, K. S., and Goudreau, G. L., Thermomechanical Analysis of Viscoelastic Solids, International Journal for Numerical Methods in Engineering, **2**(1), 45-59 (1970).

7. Haghghi-Yazdi, M. and Lee-Sullivan, P., Stress Relaxation of a Polycarbonate Blend after Hygrothermal Aging, submitted to the Mechanics of Time-Dependant Materials, (2011).

8. Guo, Y., and Bradshaw, R. D., Isothermal Physical Aging Characterization of Polyether-Ether-Ketone (PEEK) and Polyphenylene Sulfide (PPS) Films by Creep and Stress, Mechanics of Time-Dependent Materials, **11**(1), 61-89 (2007).

## 8. Acknowledgements

The authors wish to thank the Materials Laboratory at Research in Motion (RIM), Waterloo, Ontario for providing materials and technical support over the past three years. Funding from RIM and the Natural Science and Engineering Research Council of Canada Collaborative Research and Development (NSERC-CRD) program for this work is gratefully acknowledged.

## 9. Appendix

Generalized Kelvin-Voigt Model:

$$\begin{cases} \varepsilon_x = \frac{\partial u}{\partial x} \\ \varepsilon_y = \frac{\partial v}{\partial y} \\ \varepsilon_z = \varepsilon_z^e + \varepsilon_z^{an_1} + \varepsilon_z^{an_2} \\ \varepsilon_{xy} = \frac{1}{2} \left( \frac{\partial u}{\partial y} + \frac{\partial v}{\partial x} \right) \end{cases} \quad (\text{A-1})$$

$$\begin{cases} \varepsilon_x^e = \varepsilon_x - \varepsilon_x^{an_1} - \varepsilon_x^{an_2} \\ \varepsilon_y^e = \varepsilon_y - \varepsilon_y^{an_1} - \varepsilon_y^{an_2} \\ \begin{cases} \varepsilon_z^e = \frac{2}{3}G - K \\ \varepsilon_z^e = \frac{2}{3}G + K \end{cases} (\varepsilon_x^e + \varepsilon_y^e), \text{ if plane stress} \\ \varepsilon_z^e = 0, \text{ if plane strain} \\ \varepsilon_{xy}^e = \varepsilon_{xy} - \varepsilon_{xy}^{an_1} - \varepsilon_{xy}^{an_2} \end{cases} \quad (\text{A-2})$$

$$\begin{cases} e_x^e = \varepsilon_x^e - \frac{\varepsilon_{vol}^e}{3} \\ e_y^e = \varepsilon_y^e - \frac{\varepsilon_{vol}^e}{3} \\ e_z^e = \varepsilon_z^e - \frac{\varepsilon_{vol}^e}{3} \\ \varepsilon_{vol}^e = \varepsilon_x^e + \varepsilon_y^e + \varepsilon_z^e \end{cases} \quad (\text{A-3})$$

$$\begin{cases} \sigma_x = 2Ge_x^e + K\varepsilon_{vol}^e \\ \sigma_y = 2Ge_y^e + K\varepsilon_{vol}^e \\ \sigma_z = 2Ge_z^e + K\varepsilon_{vol}^e \\ \sigma_{xy} = 2Ge_{xy}^e \end{cases} \quad (\text{A-4})$$

$$\begin{cases} \sigma_x^{an_i} = \left( \frac{4}{3}G_i + K_i \right) \varepsilon_x^{an_i} + \left( K_i - \frac{2}{3}G_i \right) (\varepsilon_y^{an_i} + \varepsilon_z^{an_i}) \\ \sigma_y^{an_i} = \left( \frac{4}{3}G_i + K_i \right) \varepsilon_y^{an_i} + \left( K_i - \frac{2}{3}G_i \right) (\varepsilon_x^{an_i} + \varepsilon_z^{an_i}) \\ \sigma_z^{an_i} = \left( \frac{4}{3}G_i + K_i \right) \varepsilon_z^{an_i} + \left( K_i - \frac{2}{3}G_i \right) (\varepsilon_x^{an_i} + \varepsilon_y^{an_i}) \\ \sigma_{xy}^{an_i} = 2G_i \varepsilon_{xy}^{an_i}, i = 1, 2 \text{ (no summation convention)} \end{cases} \quad (\text{A-5})$$

$$\begin{cases} \sigma_x^{v_i} = \frac{\eta_i}{(1+\nu)(1-2\nu)} [(1-\nu)\dot{\varepsilon}_x^{an_i} + \nu(\dot{\varepsilon}_y^{an_i} + \dot{\varepsilon}_z^{an_i})] \\ \sigma_y^{v_i} = \frac{\eta_i}{(1+\nu)(1-2\nu)} [(1-\nu)\dot{\varepsilon}_y^{an_i} + \nu(\dot{\varepsilon}_x^{an_i} + \dot{\varepsilon}_z^{an_i})] \\ \sigma_z^{v_i} = \frac{\eta_i}{(1+\nu)(1-2\nu)} [(1-\nu)\dot{\varepsilon}_z^{an_i} + \nu(\dot{\varepsilon}_x^{an_i} + \dot{\varepsilon}_y^{an_i})] \\ \sigma_{xy}^{v_i} = 2G_i \tau_i \dot{\varepsilon}_{xy}^{v_i}, i = 1, 2 \text{ (no summation convention)} \end{cases} \quad (\text{A-6})$$

Generalized Maxwell Model:

$$\begin{cases} \varepsilon_x = \frac{\partial u}{\partial x} \\ \varepsilon_y = \frac{\partial v}{\partial y} \\ \begin{cases} \varepsilon_z = \frac{-\lambda(\varepsilon_x + \varepsilon_y) + \sigma_{qz}}{\lambda + 2G}, \text{ if plane stress} \\ \varepsilon_z = 0, \text{ if plane strain} \end{cases} \\ \varepsilon_{xy} = \frac{1}{2} \left( \frac{\partial u}{\partial y} + \frac{\partial v}{\partial x} \right) \end{cases} \quad (\text{A-7})$$

$$\begin{cases} e_x = \varepsilon_x - \frac{\varepsilon_{vol}}{3} \\ e_y = \varepsilon_y - \frac{\varepsilon_{vol}}{3} \\ e_z = \varepsilon_z - \frac{\varepsilon_{vol}}{3} \\ \varepsilon_{vol} = \varepsilon_x + \varepsilon_y + \varepsilon_z \end{cases} \quad (\text{A-8})$$

$$\begin{cases} \sigma_x = 2Ge_x + K\varepsilon_{vol} + \sigma_{qx} \\ \sigma_y = 2Ge_y + K\varepsilon_{vol} + \sigma_{qy} \\ \sigma_z = 2Ge_z + K\varepsilon_{vol} + \sigma_{qz} \\ \sigma_{xy} = 2Ge_{xy} + \sigma_{qxy} \end{cases} \quad (\text{A-9})$$

$$\begin{cases} q_{x_i}^e = q_{x_i} - \frac{q_{x_i} + q_{y_i} + q_{z_i}}{3} \\ q_{y_i}^e = q_{y_i} - \frac{q_{x_i} + q_{y_i} + q_{z_i}}{3} \\ q_{z_i}^e = q_{z_i} - \frac{q_{x_i} + q_{y_i} + q_{z_i}}{3} \\ i = 1, 2 \text{ (no summation convention)} \end{cases} \quad (\text{A-10})$$

$$\begin{cases} \sigma_{q_x} = 2G_i q_{x_i}^e + K_i (q_{x_i} + q_{y_i} + q_{z_i}) \\ \sigma_{q_y} = 2G_i q_{y_i}^e + K_i (q_{x_i} + q_{y_i} + q_{z_i}) \\ \sigma_{q_z} = 2G_i q_{z_i}^e + K_i (q_{x_i} + q_{y_i} + q_{z_i}) \\ \sigma_{q_{xy}} = 2G_i q_{xy_i}^e, i = 1, 2 \text{ (sum. convention)} \end{cases} \quad (\text{A-11})$$

$$\begin{cases} \dot{q}_{x_i} + \frac{1}{\tau_i} q_{x_i} = \dot{\varepsilon}_x \\ \dot{q}_{y_i} + \frac{1}{\tau_i} q_{y_i} = \dot{\varepsilon}_y \\ \dot{q}_{z_i} + \frac{1}{\tau_i} q_{z_i} = \dot{\varepsilon}_z \\ \dot{q}_{xy_i} + \frac{1}{\tau_i} q_{xy_i} = \dot{\varepsilon}_{xy} \\ i = 1, 2 \text{ (no summation convention)} \end{cases} \quad (\text{A-12})$$