

M. Cavenago¹, P. Veltri², E. Gazza², G. Serianni², P. Agostinetti²

Negative Ion Beams and Secondary Beams



¹ INFN, Laboratori nazionali di Legnaro, Legnaro, Italy

² Consorzio RFX, Euratom-Enea association for Fusion, Padova, Italy

Introduction

- Neutral Beam injectors (NBI) are fundamental to heat the plasma confined in the fusion devices.
- Neutrals are produced by neutralization of charged particles beam
- Due to neutralization efficiency at the high energy required for the ITER tokamak the use of negative ions is compulsory^[1].
- Related simulations involve several coupled physics and engineering issues, even if we restrict to beam acceleration only.

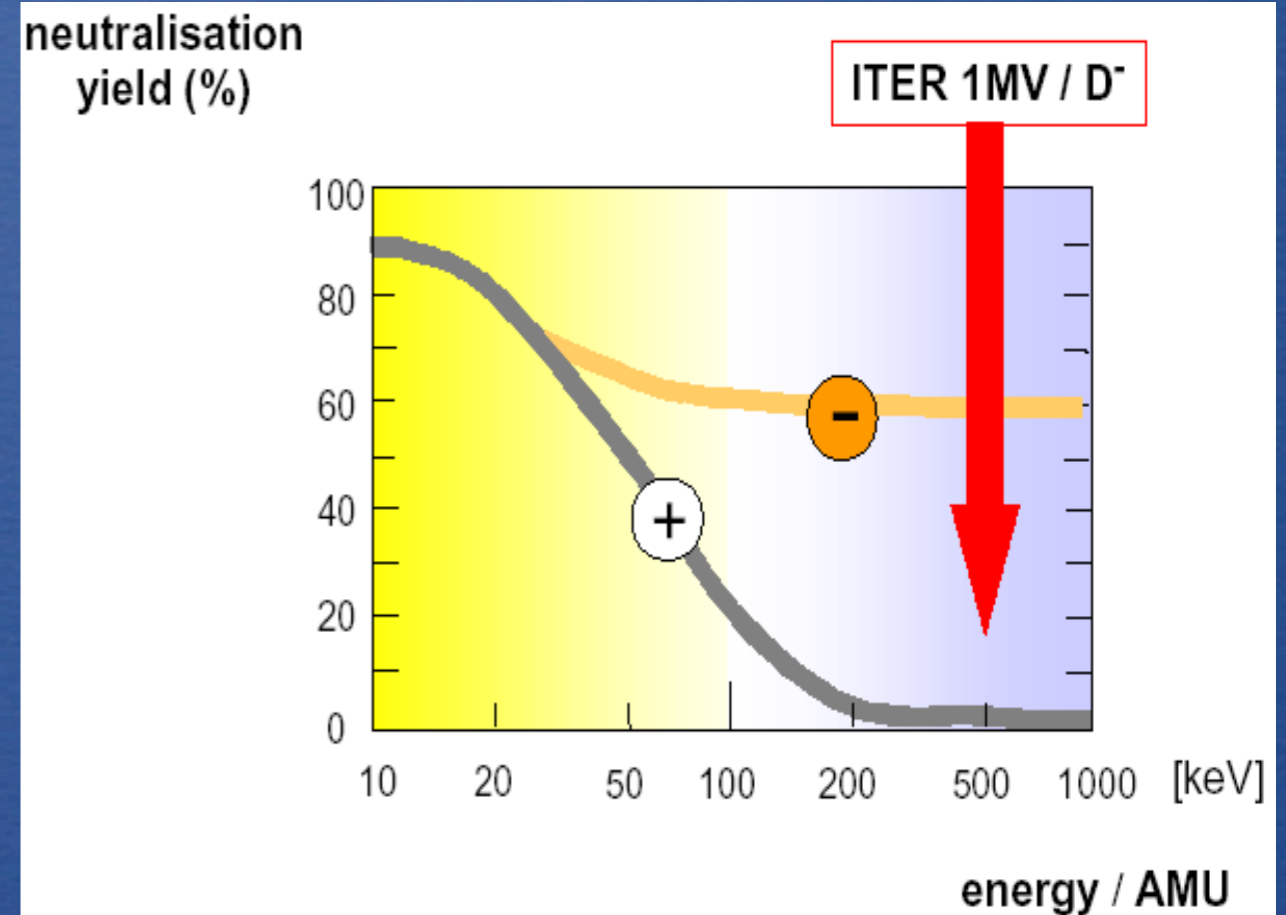
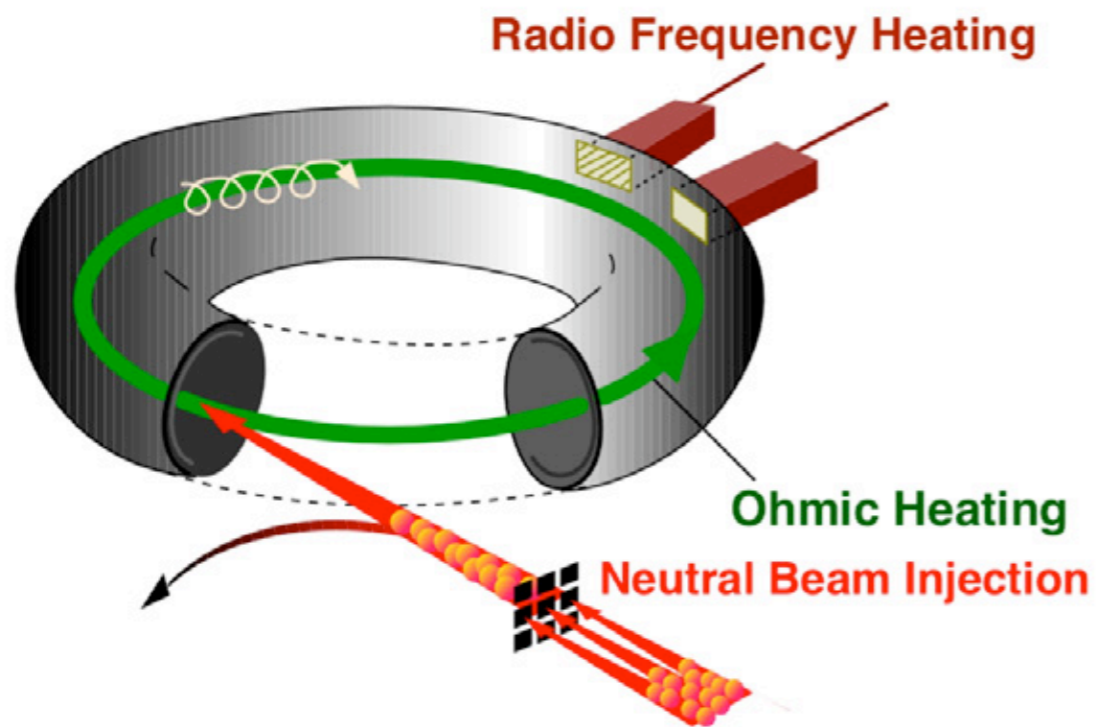

Introduction(2)

Beam acceleration modeling is usually divided in different 2D or 3D simulations:

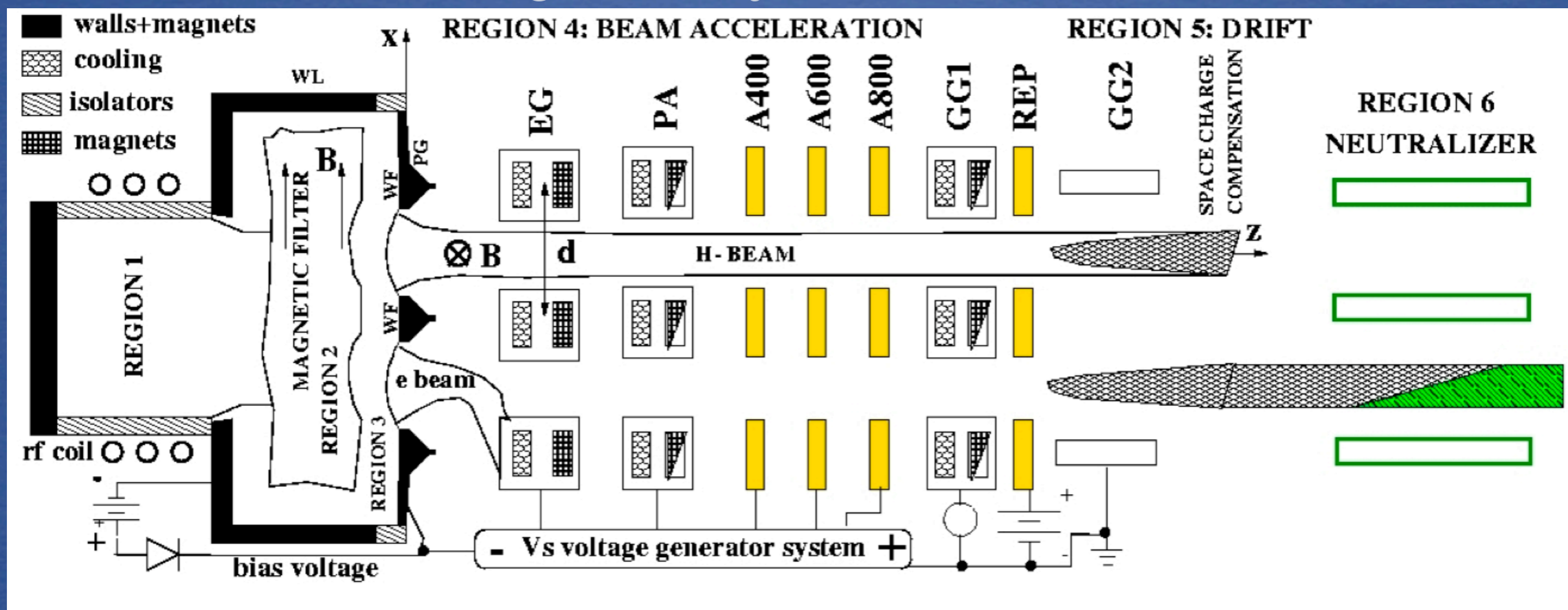

Scheme of a negative ion based NBI

- Magnetic field simulation [2]
- Gas flow [3]
- Selfconsistent FEM solution for Electric field [4]
- Simulation of secondary particles generation and transport [6]
- Electrode heating and stress modeling [5],[7]

The family of codes we are going to present can cover them all.

The Bypo code [8], Model overview

Iterative N-PDE Poisson Solver.

Basic equations, since first versions:

$$\lambda_D^{-2} \nabla^2 u = n_{H^+} - n_{H^-} - n_e$$

Adimensional Poisson Equation

with:

$$u = -eV/k_B T$$

$$n = N/N_0$$

$$n_{H^+} = K_0 \exp(u - u_{cr})$$

NOTE:

T = Average plasma temperature ($k_B T \approx 1 \text{ eV}$)

N_0 = Negative particle density inside plasma

$K_0 \approx 0.99$ To fulfill plasma quasi neutrality.

$n = N/N_0$;

t_H, t_e = Starting energy/ $k_B T$

$f(x, v)$ = Phase space distribution

$$n_{H^-} = j_{\Sigma_{H^-}} / \sqrt{t_H - 2(u - u_{cr})}$$

$$n_e = j_{\Sigma_e} / \sqrt{t_e - 2(u - u_{cr})}$$

Expressed in terms of the quantity j_Σ .

$$j_\Sigma(z, x) = \int f(x, v) |v| d^3 v$$

calculated from the ray map at each iteration.

The Bypo code (2)

Code evolution

- Bypo 15: Scaling, Triode geometry, Periodic Boundary conditions, ...
- Bypo 16: Space charge compensation model, stripping module...
- Bypo 17: Gas flow module , ion mass, ...

What's New in Bypo 18:

- Improved initialization procedures and procedures to increase numerical stability allow to handle full plasma current density:

Degrees of freedom=338000

Debye Length=0.014mm

Minimum mesh size=0.008 mm

- Approximate solution for cylindrical electrodes, considering only the $m=1$ multipole in $u(x,\theta,z)$.

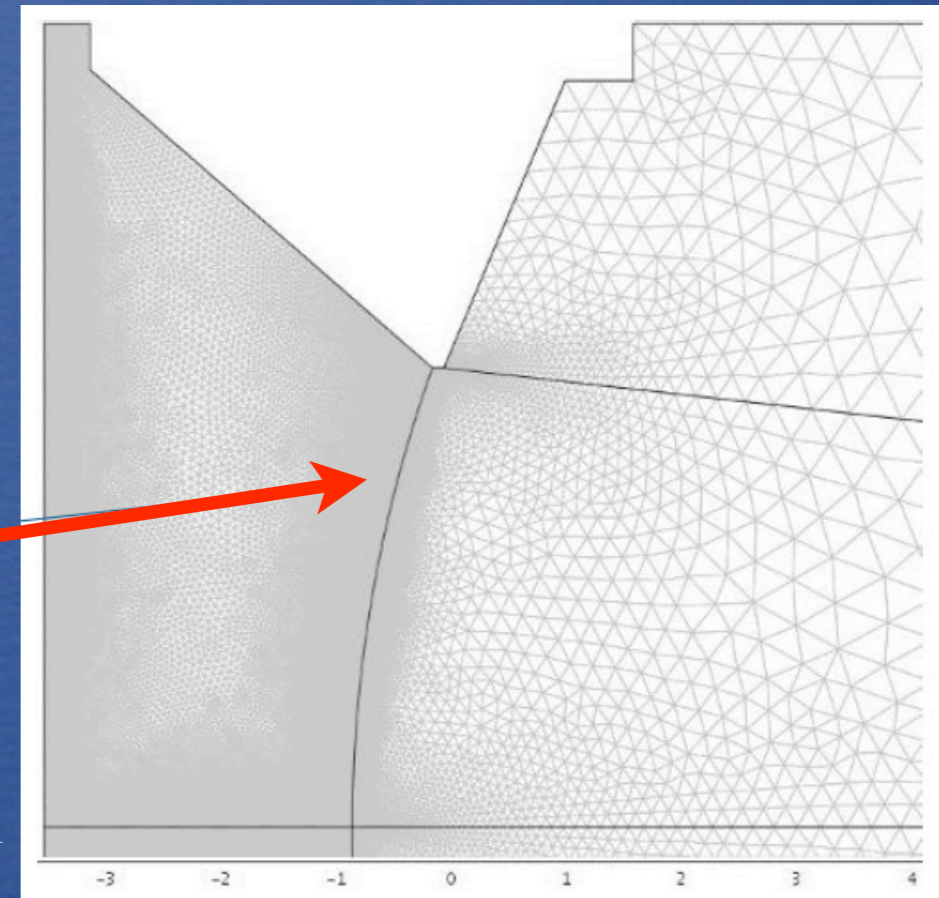

Bypo Add-on's: Atomic and molecular database

A complete set of all possible reactions of beam particles with residual gas involves thousands of cross sections.

A progressive conversion of reaction data into structured variables allow a fast consultation and makes them available to Bypo or other codes.

At low energy, inside the sources, internal transition between atomic and molecular level should be considered, while in the high energy range of the beam region a restricted set of reactions can be sufficient to describe relevant processes:

H ions against H₂ target:



Together with their partner reaction, in which H₂ is ionized, like in

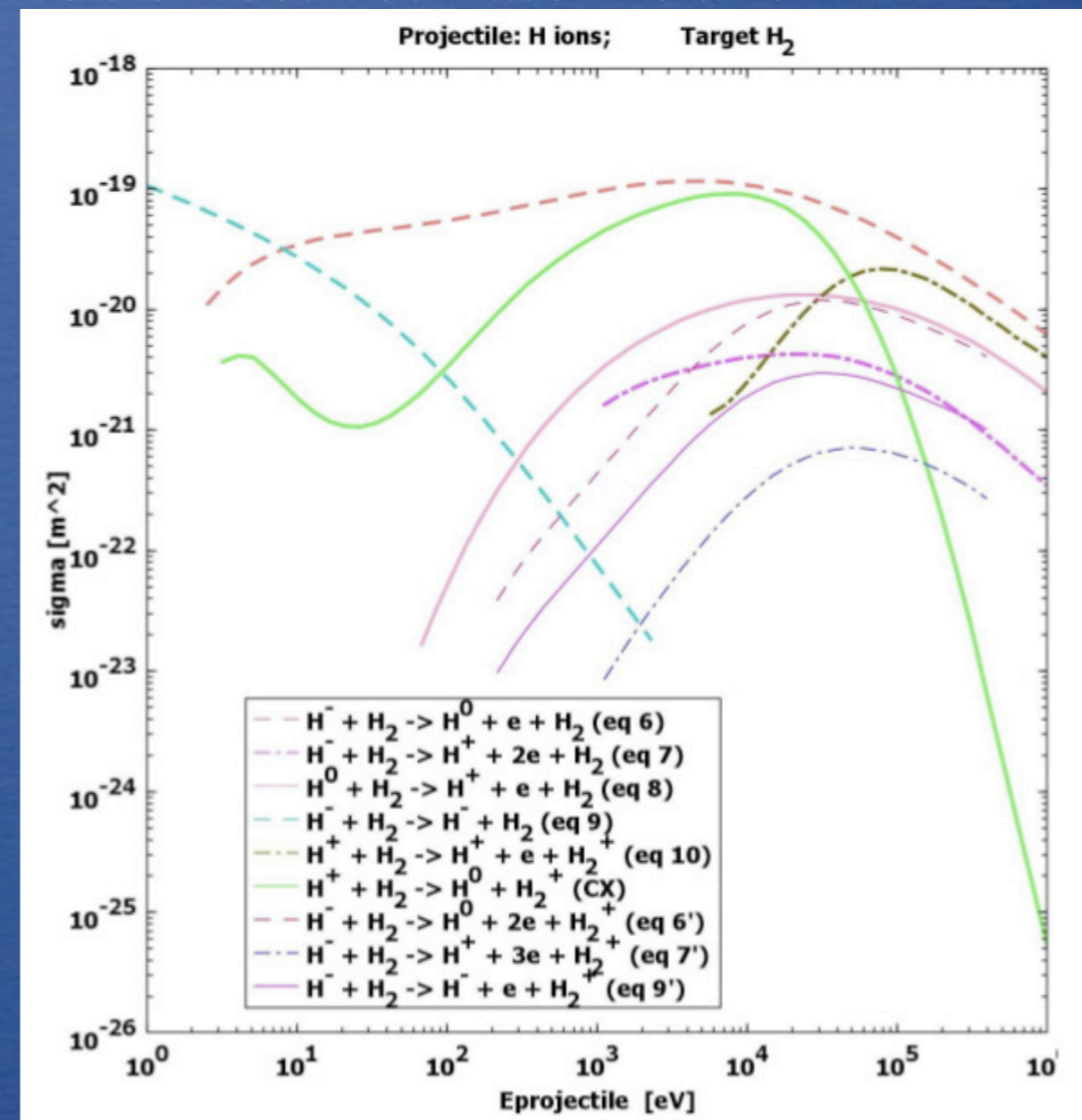

Secondary beams

Scope: to re-distribute part of the Bypo current density, according to the trajectories of secondaries.

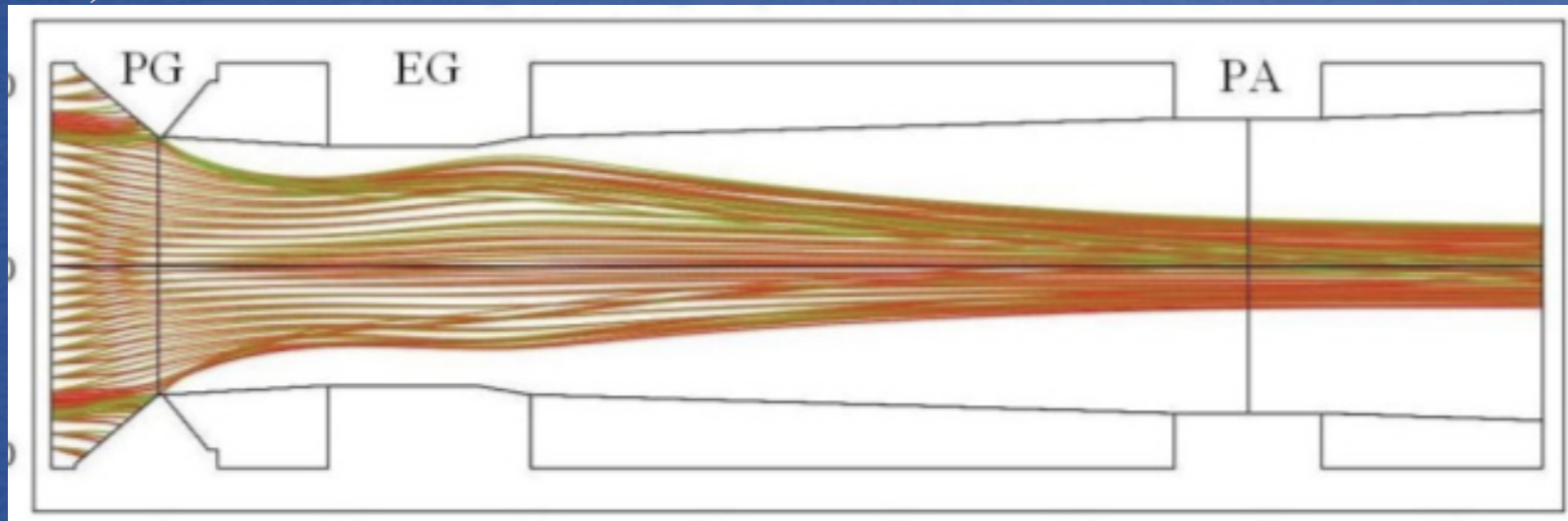

Each H^- primary ray is divided in n intervals of length Δz , than the probability for each reaction to occur is calculated from the standard expression:

$$P = 1 - \exp\left(-\frac{n_g(z) \cdot \sigma(E)}{\Delta z}\right)$$

n_g = Residual gas density
 $\sigma(E)$ = Total cross section

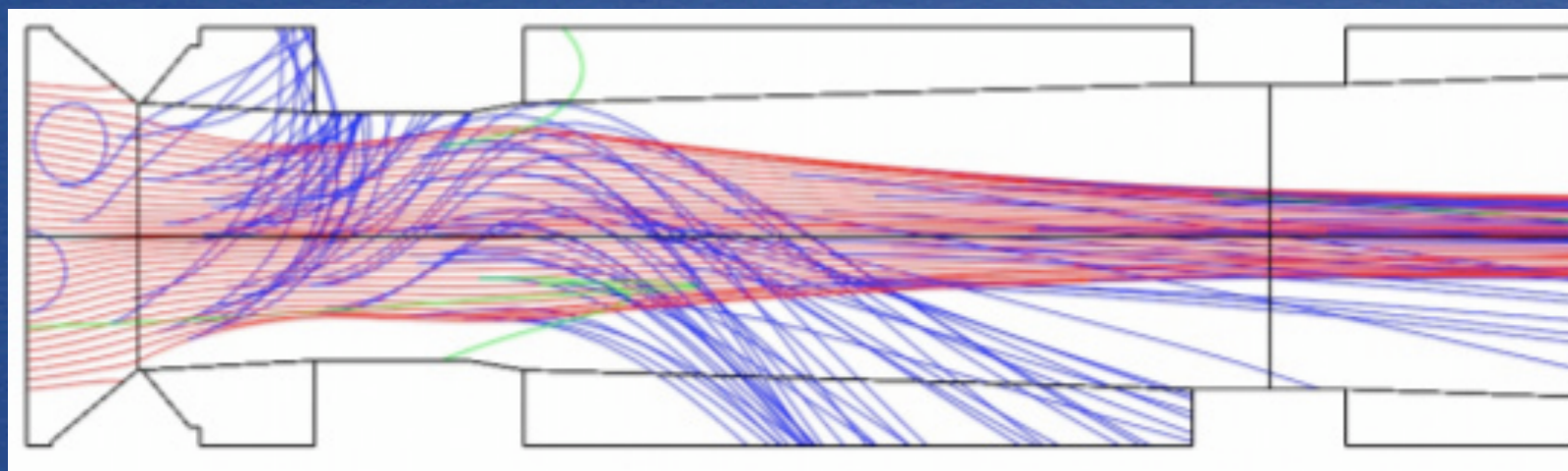

Secondaries moves according to the EM fields calculated by Bypo, and their space charge is recorded

Secondary beams

Electrons are produced by several reactions, but their high velocity makes their density low: $n_{H^-} \sim 0.1 - 2 N_0$; $n_e \sim 10^{-3} - 10^{-4} N_0$.



e^- trajectories

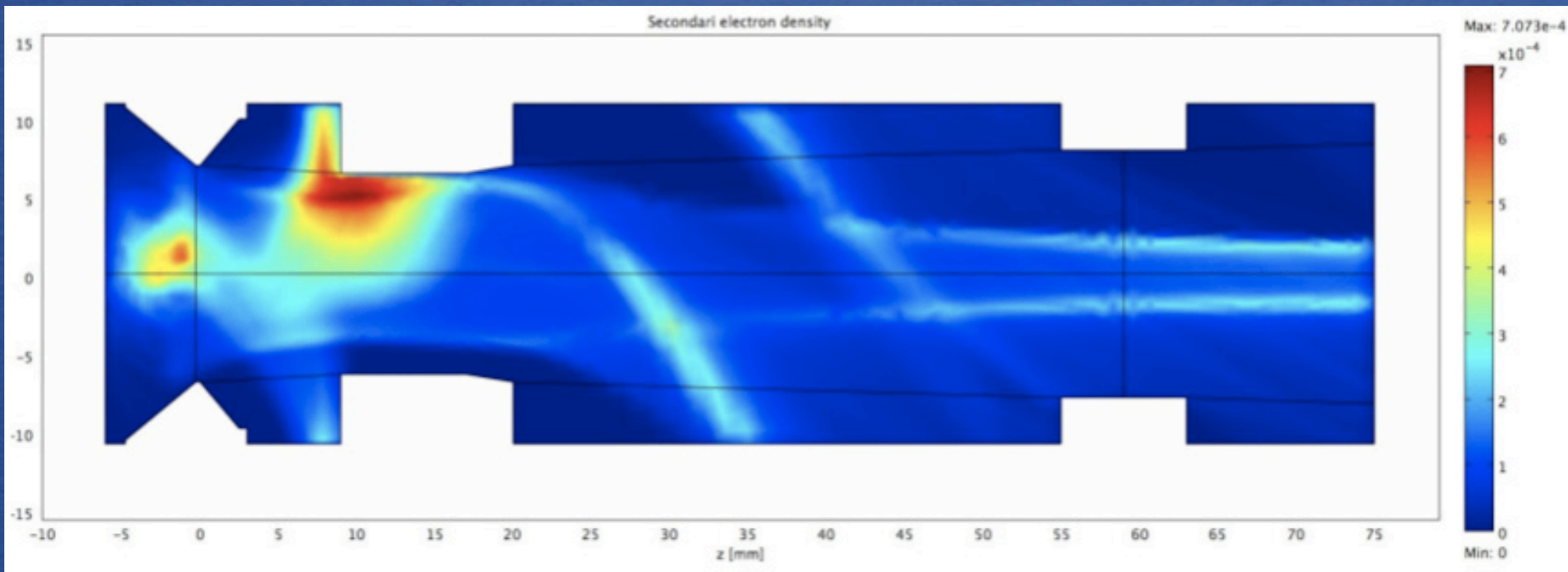

e^- Space charge

However they still gives a small contribution to the heating of the grids.

Secondary beams

Positive ions H^+ are mainly produced by double stripping of H^- beams. They form a current streaming backward toward the source.

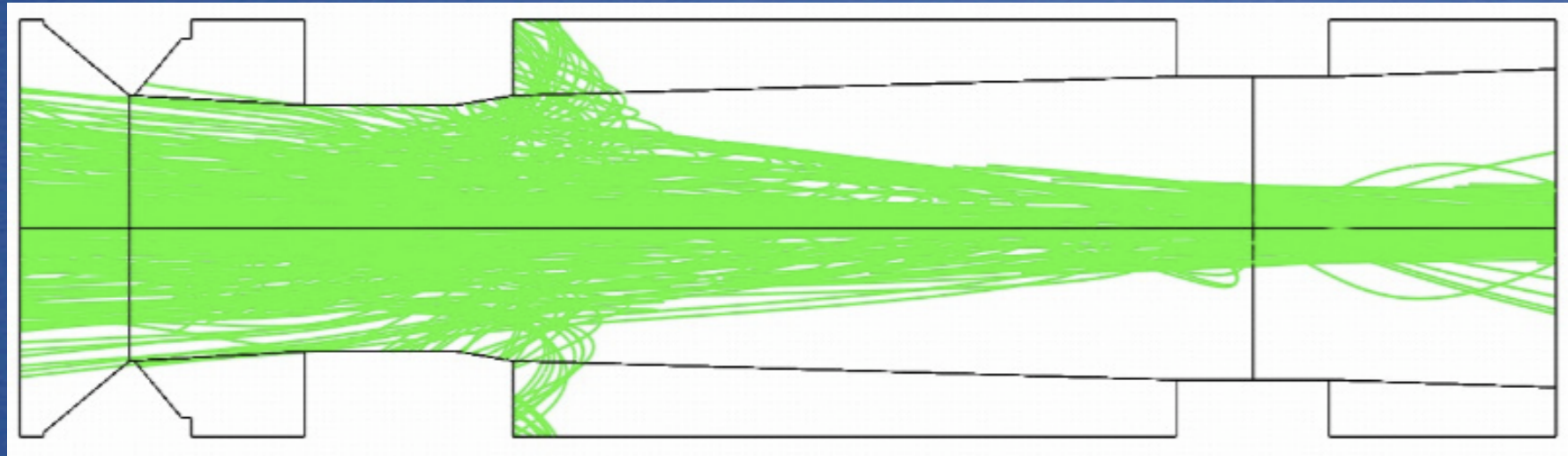

H^+ ions trajectories

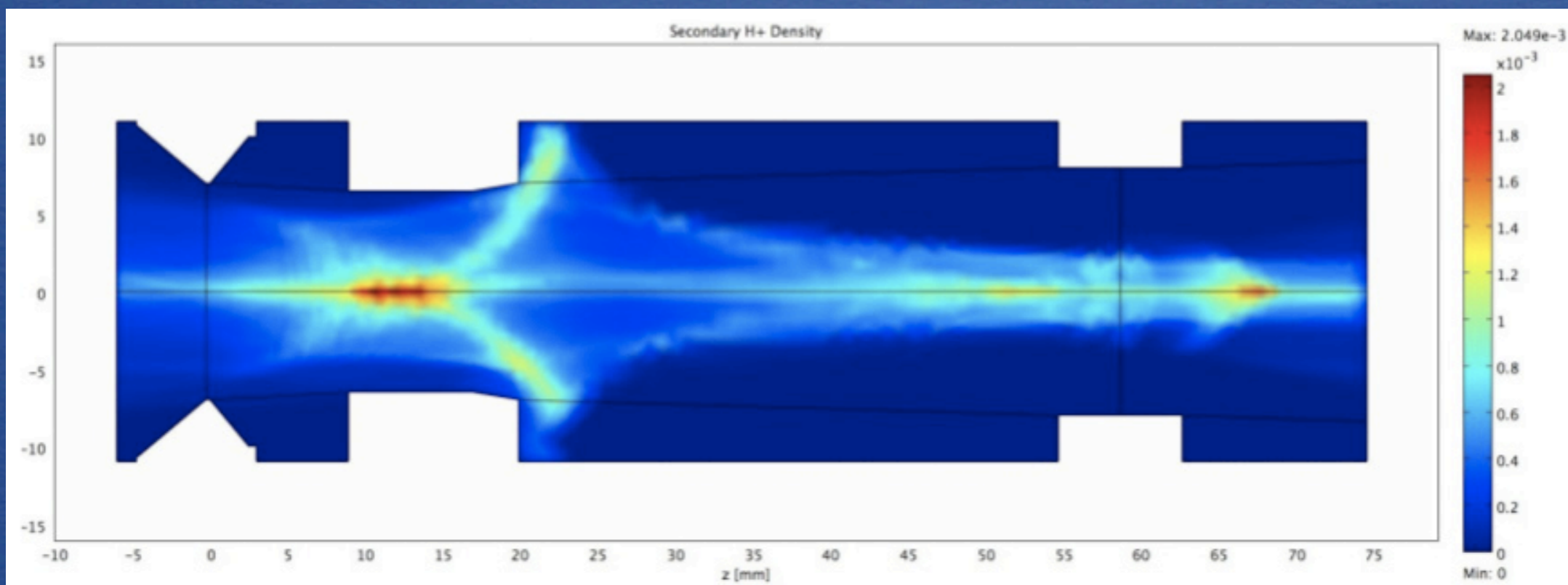

H^+ Space charge

Secondary beams

Positive ions H^+ are mainly produced by double stripping of H^- beams. They form a current streaming backward toward the source.

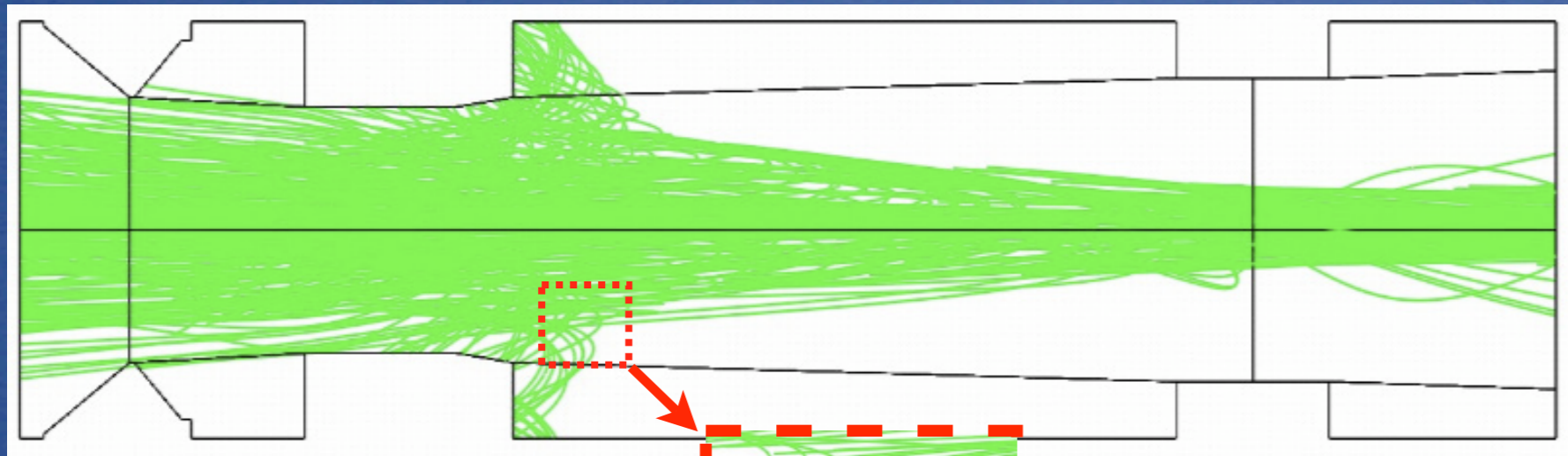

H^+ ions
trajectories

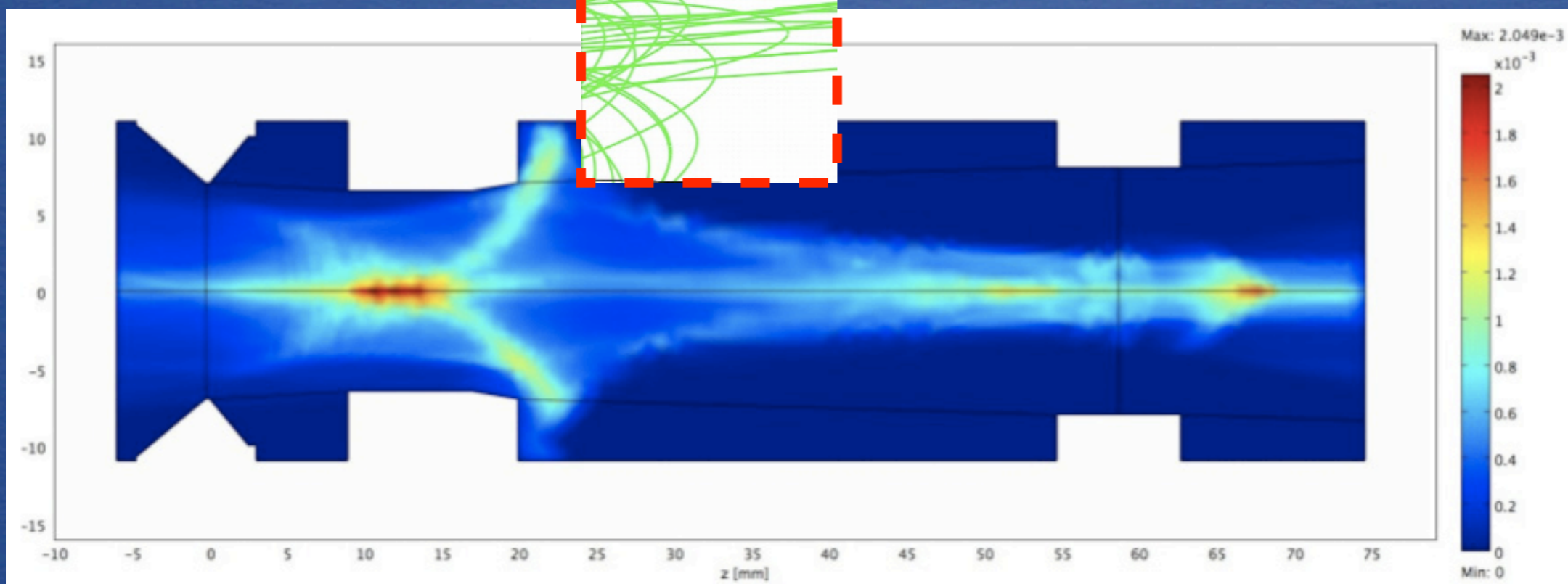

H^+ Space charge

Note that peak of density appear where ions reverse their motion ($v \sim 0$)

Secondary beams

H_2^+ ions come from the ionization of the background H_2 gas. Since they have a low initial velocity, their contribution to space charge can be high.

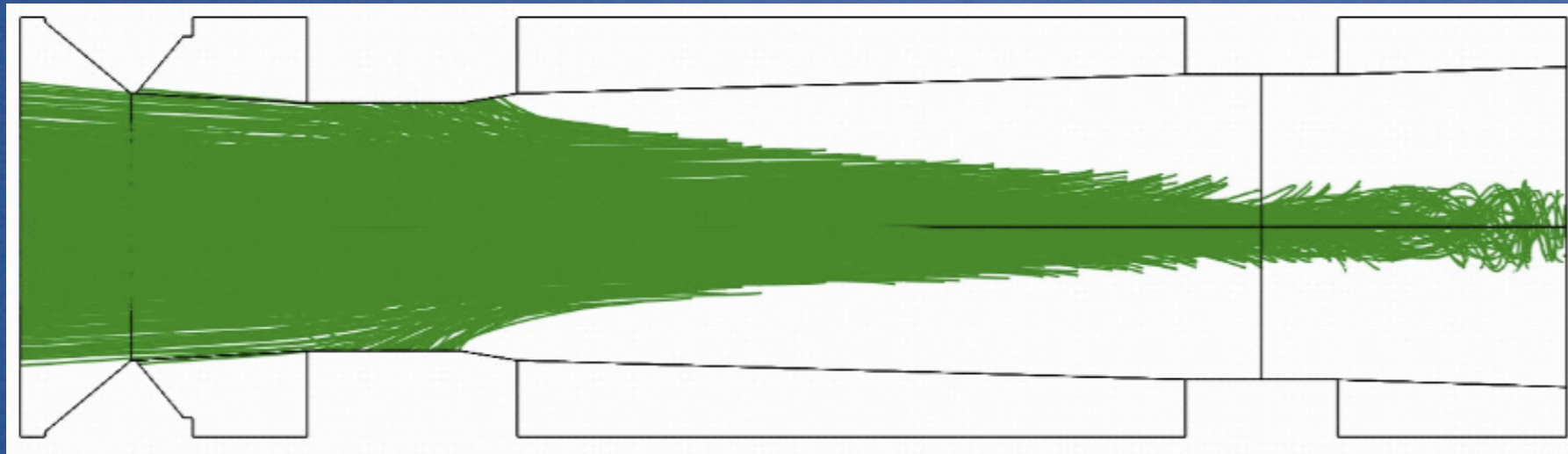

H_2^+ ions trajectories

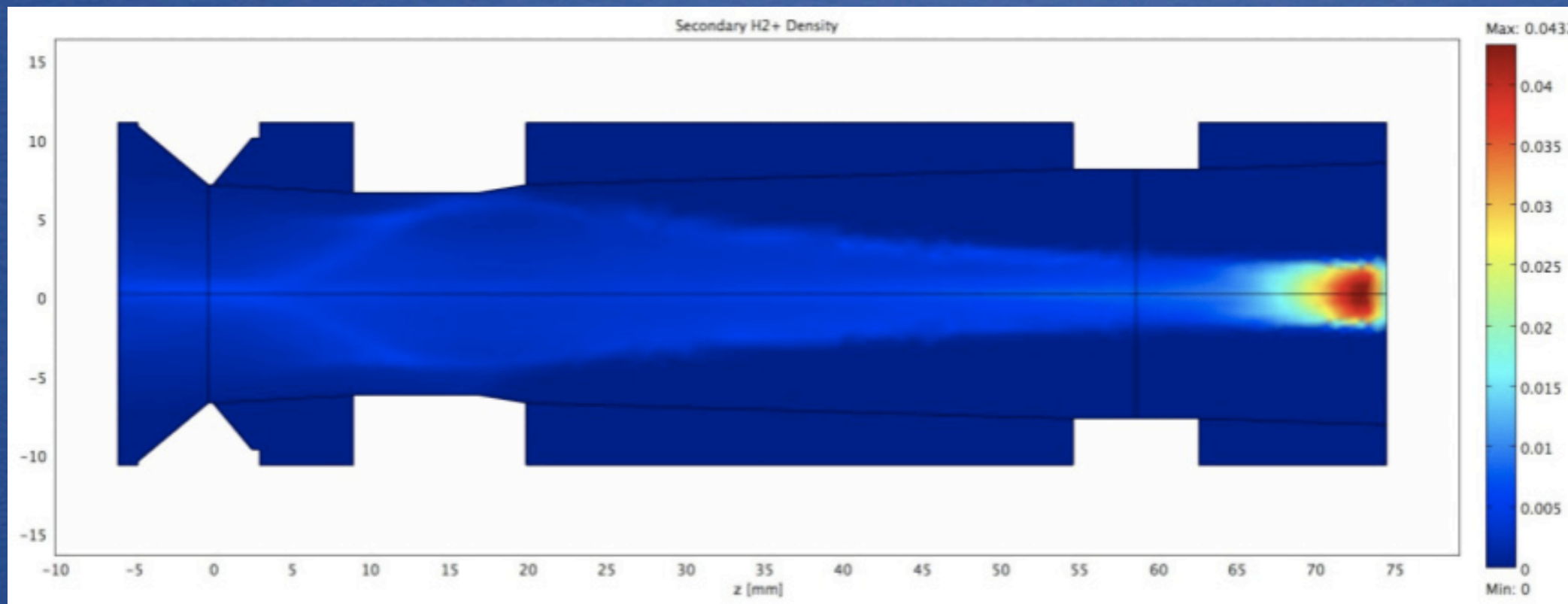

H_2^+ Space charge

Secondary beams

H_2^+ ions come from the ionization of the background H_2 gas. Since they have a low initial velocity, their contribution to space charge can be high.

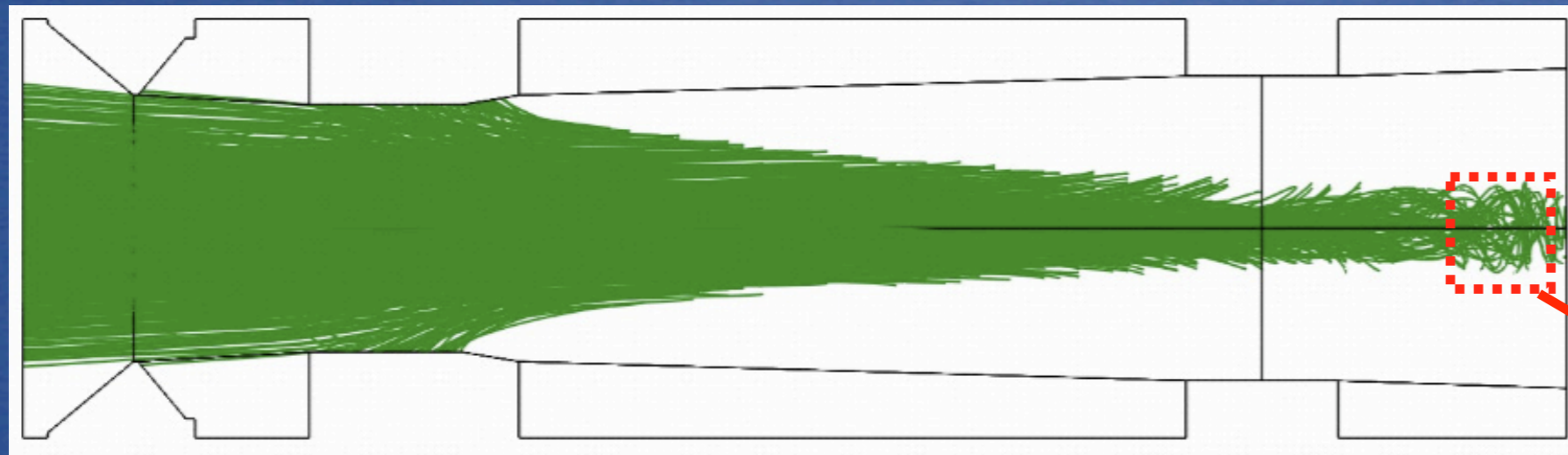

H_2^+ ions trajectories

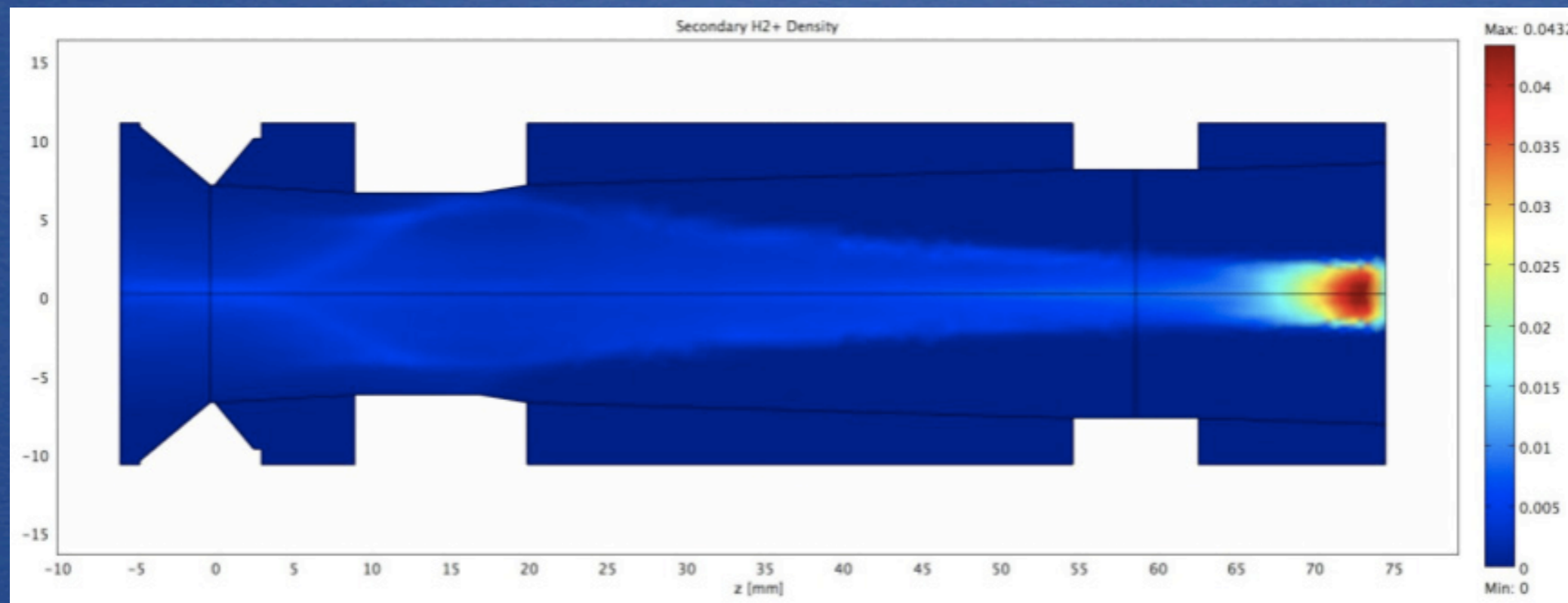

H_2^+ Space charge

Secondary beams

H_2^+ accumulation at the exit of the grounded grid can cause space charge compensation, a standard issue in accelerator physics [9].

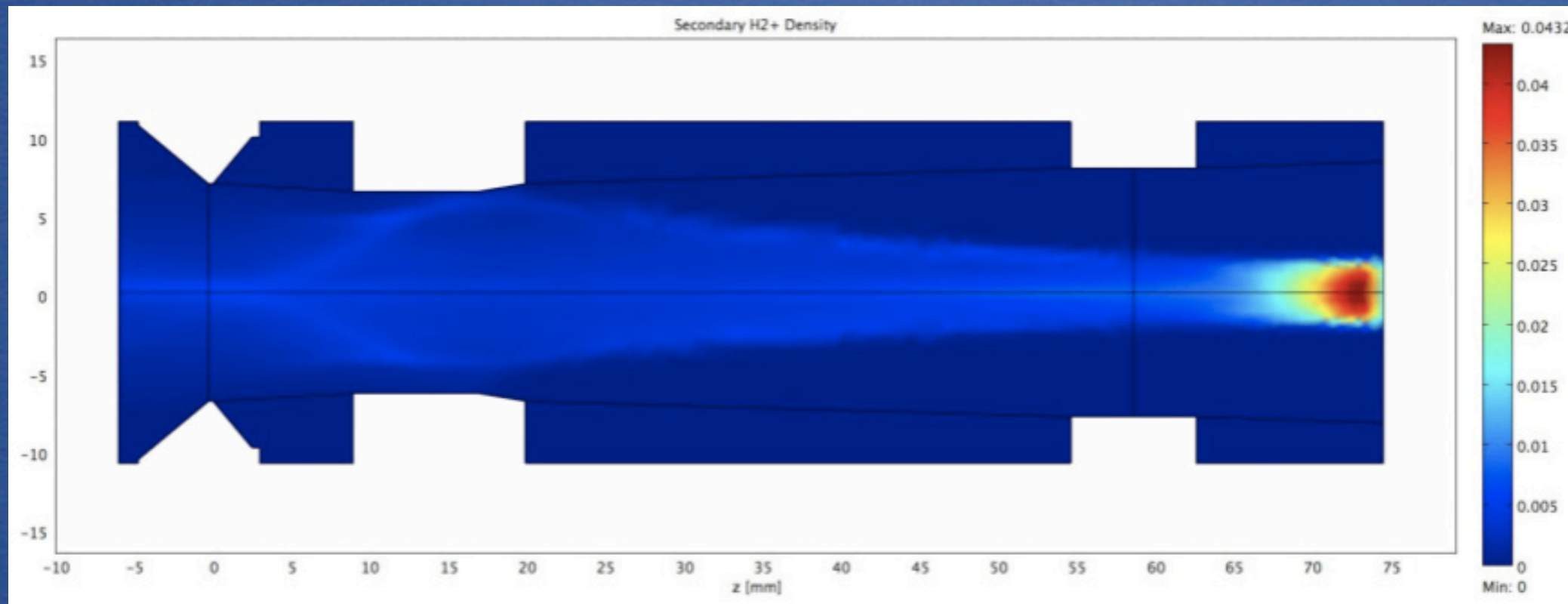

H_2^+ Space charge

This effect was already included since bypo 17, as an extrapolation to 2D of models described elsewhere [10] [11].

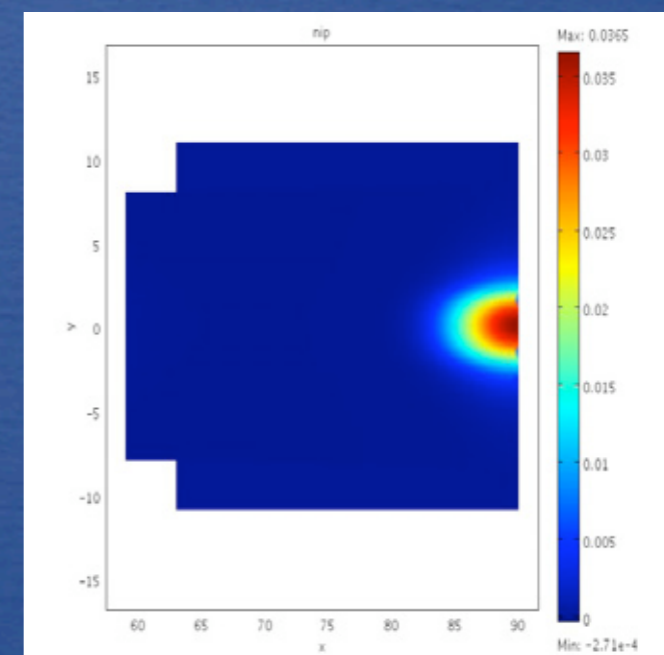

H_2^+ Space charge
(Bypo 17 model)

Results from both methods qualitatively agrees.

Thermal Simulations

Bypo can also compute the heat load due to particle fluxes on the grids. In particular considerable heat loads are foreseen on the extraction grid (EG) front, where electrons are deflected by the B field.

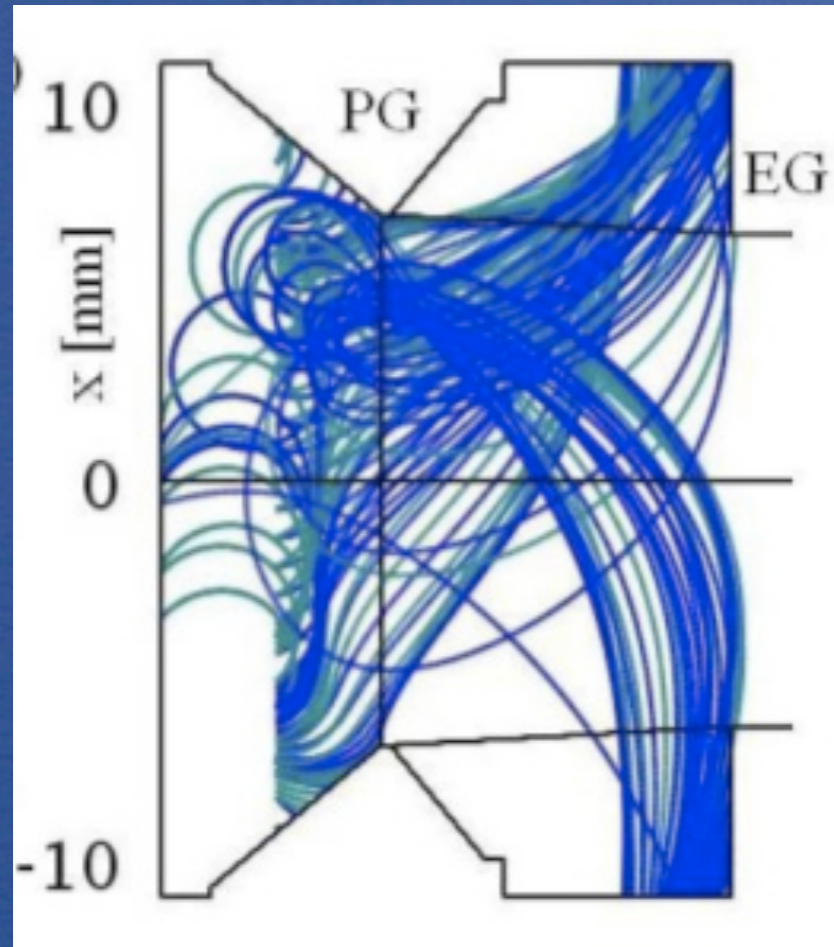

Power deposition on EG (W/m^2)

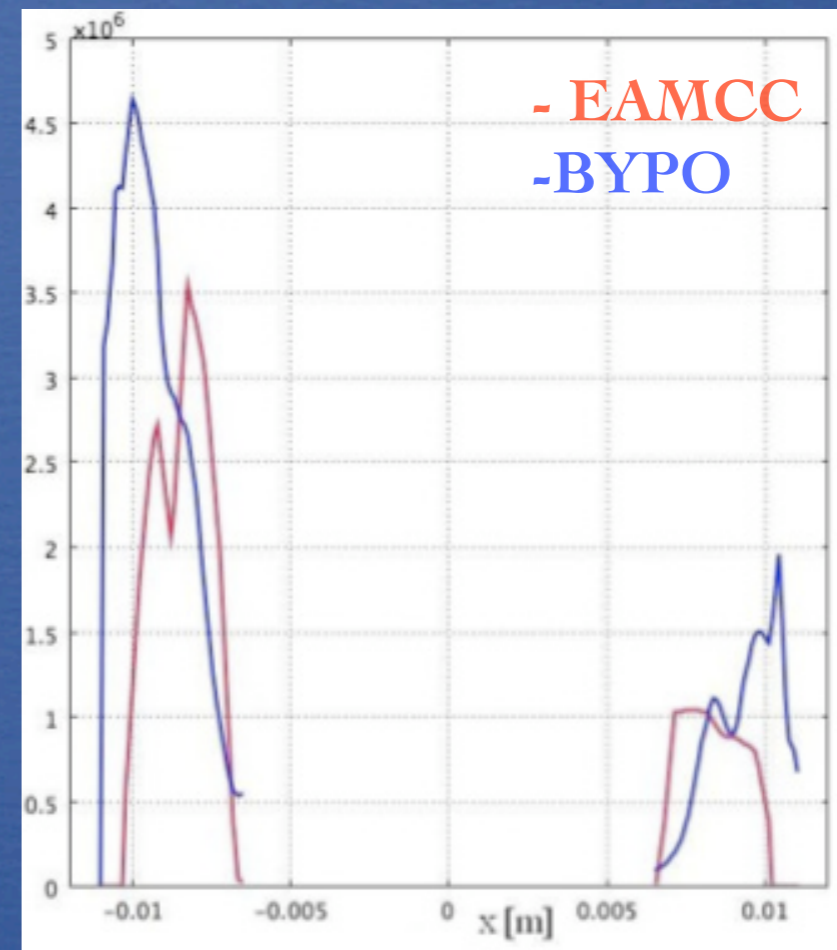

This kind of analysis can be compared with the results of the Montecarlo code EAMCC [6].

Thermal Simulations, 2D

A first analysis was performed on the 2D geometry, with the Comsol stationary heat transfer module, considering copper grids (Conductivity 400 W/m K), and a cooling pipe, with T fixed ($T=75^{\circ}\text{C}$).

Bypo
Heat flux

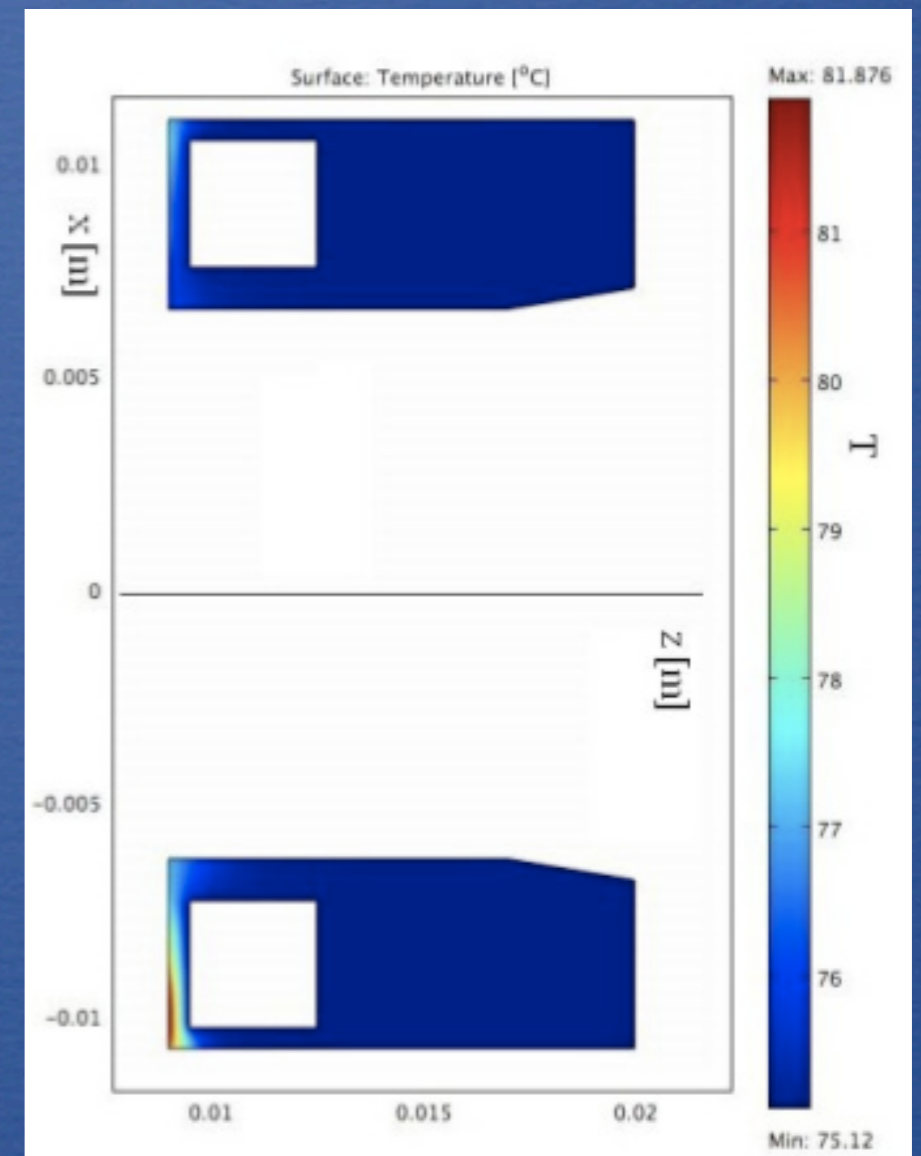
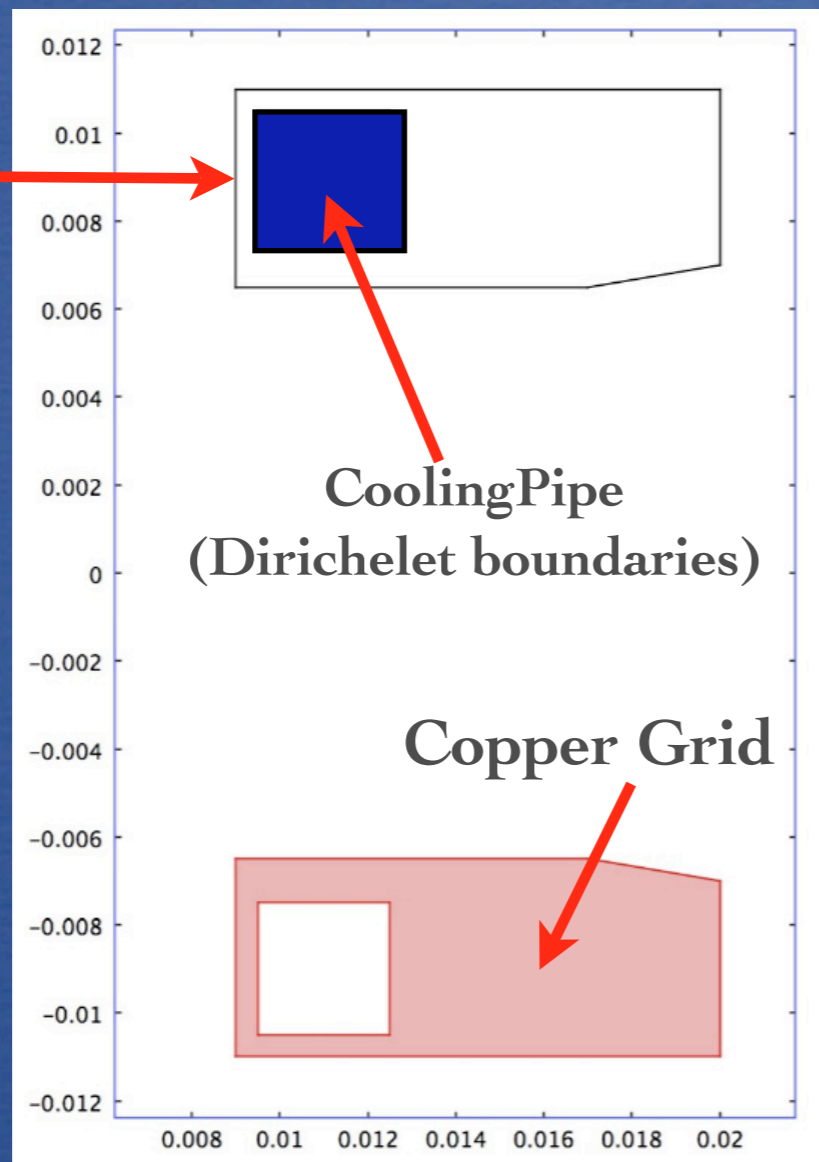

Result: The temperature rise is limited to 10 K, and a clear peak is found in the lower part of the extraction hole.

Thermal Simulations, 3D

Using the real 3D geometry, we can either use the EAMCC flux, P_E , or an extrapolation of the Bypo flux, along the y direction, as: $P_b(x,y)=1/2*(1+\cos\theta) P_B(r)+1/2*(1-\cos\theta) P_B(-r)$

Power Density [W/m²]

Temperature [°C]

EAMCC

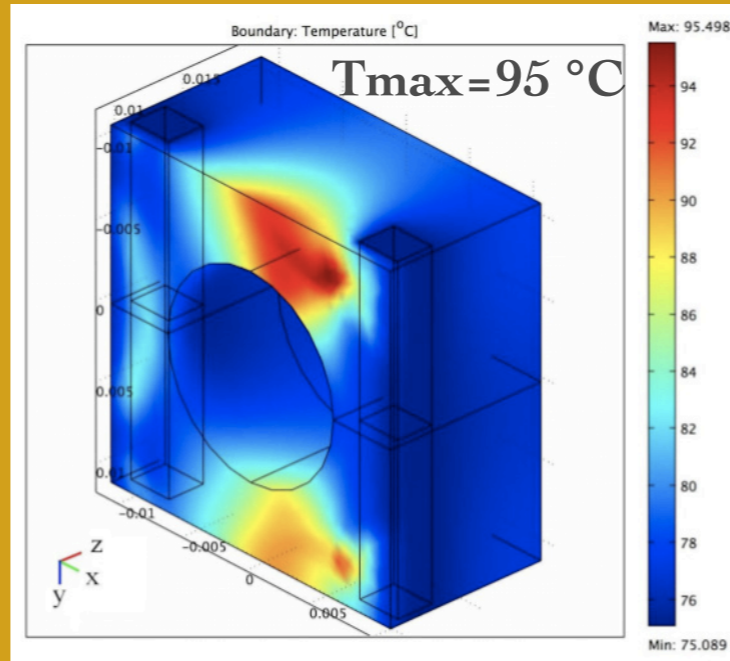
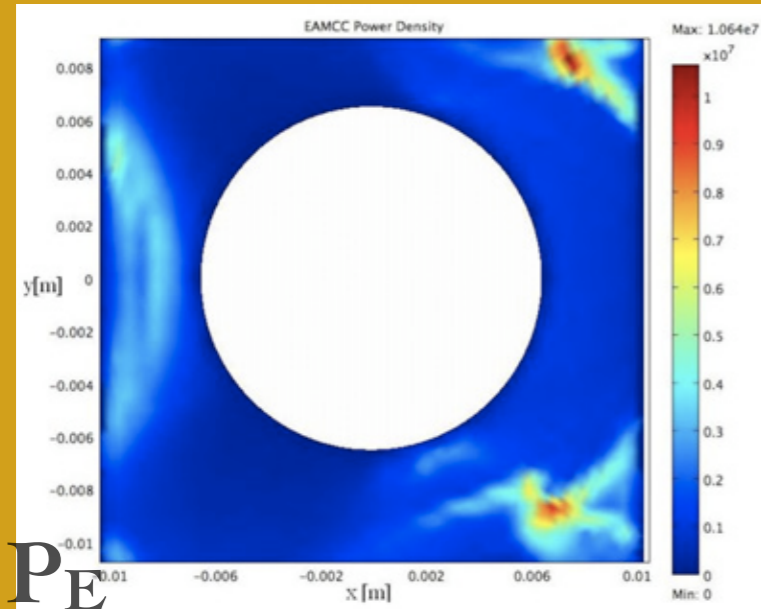

Result:
A good agreement is found between the two codes.
Note in both cases the hottest peaks move toward uncooled region.

BYPO

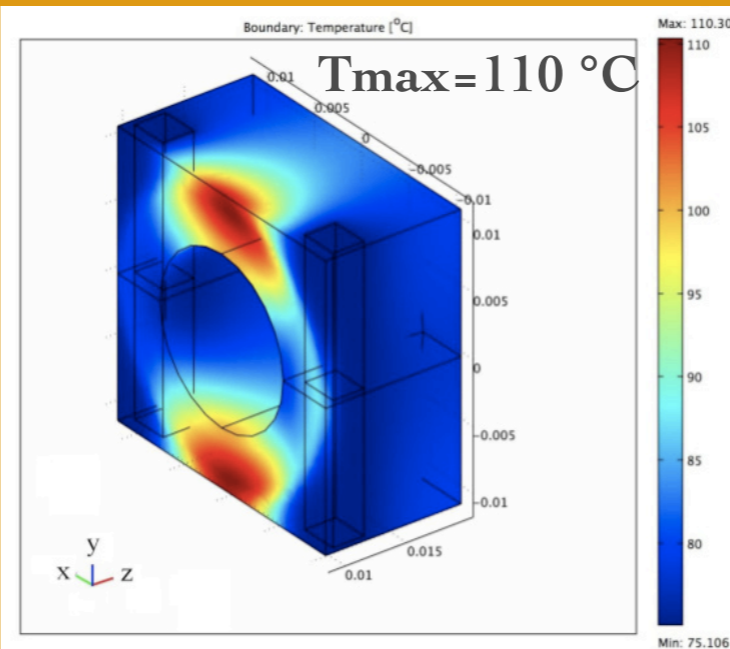
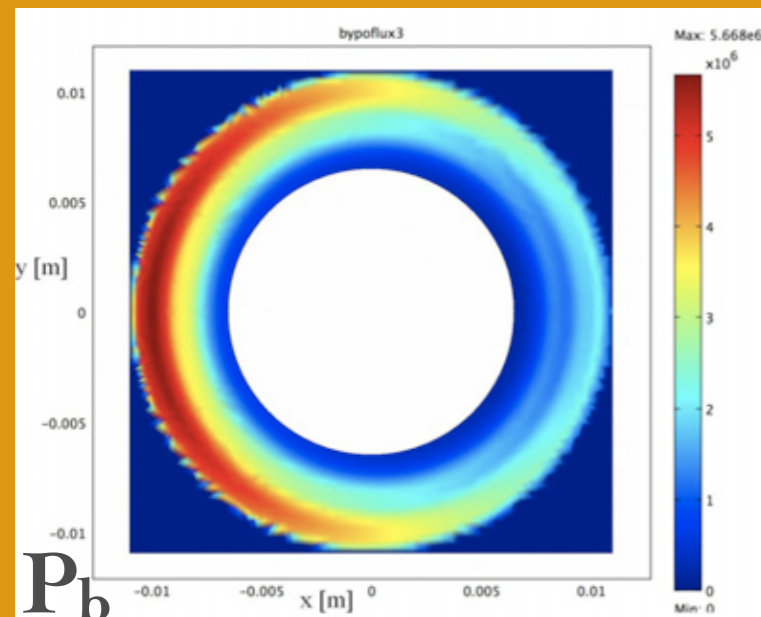

Also both total power depositions are close:
from boundary integration we find:
 $P_{BTot}=435 \text{ W}+8.6 \text{ W}$
 $P_{ETot}=450 \text{ W}+13 \text{ W}$

Conclusion

- At present dozen of codes are employed to simulate the physics of ion beams and sources.
- The necessity for them to communicate with each other requires supplementary work and sometimes needs strong compromises.
- Bypo and related codes are fastly evolving, allowing the modeling of several NBI aspects, through a single multiphysics environment.
- Further work to include more effects or to optimize what is already included, is already in progress.

